



KATALOG PRODUKTÓW

BETON
ARCHITEKTONICZNY

PRODUCT CATALOG



www.styl-bet.pl

NASZA FIRMA

Historia naszej firmy sięga drugiej połowy lat osiemdziesiątych ubiegłego stulecia. Wyjazd do Szwecji przerodził się w poczucie misji przeniesienia tamtejszych standardów estetyki przestrzeni miejskich na polski grunt. Owocem doświadczenia tam zdobytego oraz głębokiego pragnienia odczarowywania szarości polskich miast jest Styl-Bet.

Od 25 lat przyczyniamy się do poprawy wizerunku naszych miast, ulic i ogrodów. W parkach i na skwerach tworzymy przestrzenie, w których mieszkańcy mogą i chcą się spotykać. W dzielnicach oddzielamy to, co wspólne od tego, co prywatne. W przydomowych podwórkach budujemy miejsca spotkań człowieka z naturą. Uważamy, że najważniejszym elementem miasta jest człowiek i dla jego bezpieczeństwa, wygody oraz zadowolenia współtworzymy infrastrukturę.

Zagospodarowanie Dworca Głównego w Malmo było dotąd jednym z najbardziej wymagających, ale jednocześnie nobilitujących realizacji. Nasza estetyka inspirowana skandynawską prostotą została doceniona u źródła. Jednak najistotniejszym dla nas wyróżnieniem jest zaufanie każdego Klienta, który pozwala właśnie nam uczestniczyć w kreowaniu swojej przestrzeni, tak prywatnej jak i publicznej.



Andrzej Juczkowski



Leszek Paradowski

OUR COMPANY

The history of our company dates back to second half of eighties in the last century. A trip to Sweden turned into a mission to bring the local esthetics standards common for municipal areas to Poland. Styl-bet is a child of combination of our Swedish experience and a deep desire to change the ubiquitous somberness of Polish cities.

For 25 years we have been contributing to improving the image of our cities, streets and gardens. In parks and squares we create areas for residents to meet. In neighborhoods we separate the common from the private. In gardens we build space for a man to interact with nature. We believe that a person is the key element of a city and we build infrastructure for their comfort, safety and pleasure.

The development of Malmo Main Station has been one of our most demanding and prestigious implementations. Our esthetics inspired by Scandinavian simplicity was appreciated at source. However, what is the most significant aspect of our work is the Customer's trust. We are happy to be a part of the process of developing the private and public areas.

TECHNOLOGIA

BETON ARCHITEKTONICZNY

Technologia pozwalająca na ukazanie natury betonu i jego nieograniczonych możliwości. To Klient decyduje o formie produktu betonowego, jego barwie i fakturze. Oferujemy gotowe rozwiązania i realizację indywidualnych projektów, dobór kolorów – od naturalnej szarości, przez ascetyczną biel, aż po całą paletę barwników oraz możliwość strukturyzacji powierzchni. W tym wypadku jedynym co nas ogranicza jest wyobraźnia Klienta i prawa fizyki.



TECHNOLOGY

ARCHITECTURAL CONCRETE

A technology that presents the potential of concrete's nature. It is Customer who decides about product's shape, color and texture. We offer ready solutions as well as realize individual projects within the scope of the form, tint choice – from natural grey and ascetic white up to a whole range of pigments, as well as the possibility of surface structuring. In this case all that limits us is Customer's imagination and the law of physics.

KOLORY I WZORY

COLORS AND TEXTURES

NATURAL CONCRETE

■ BETON NATURALNY

BETON BIAŁY

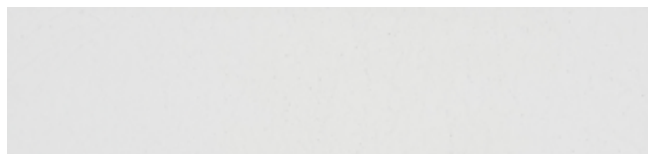

WHITE CONCRETE

BETON SZARY

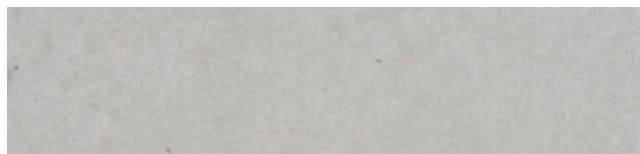

GREY CONCRETE

INTEGRALLY COLORED CONCRETE

■ BETON BARWIONY

ŻÓŁTY

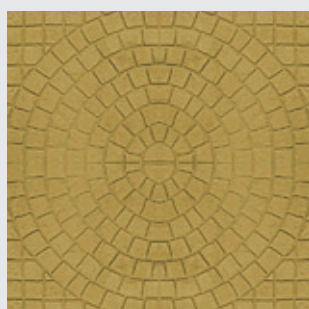

YELLOW

CZERWONY

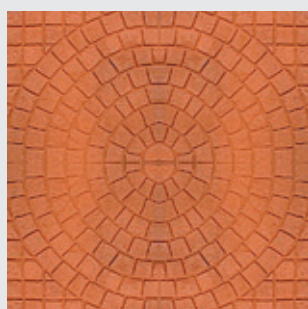

RED

BRAZOWY

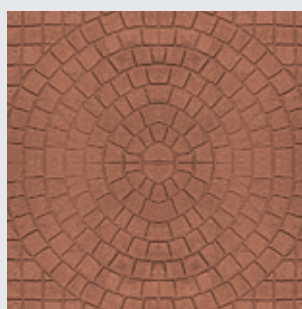

BROWN

ANTRACYT

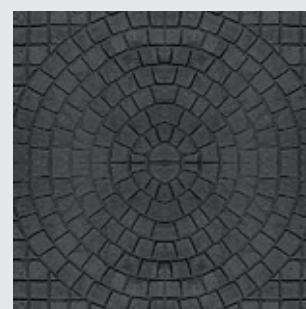

ANTHRACITE

PAINTED CONCRETE

■ BETON MALOWANY

BIAŁY

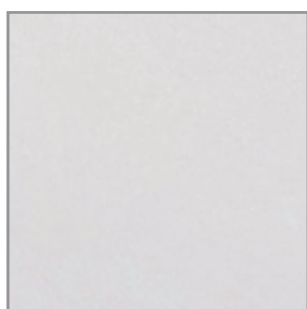

WHITE

SZARY

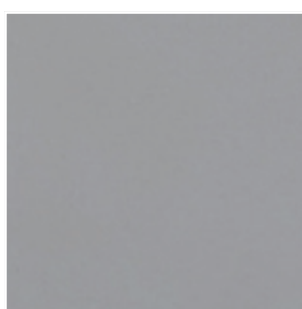

GREY

CZARNY

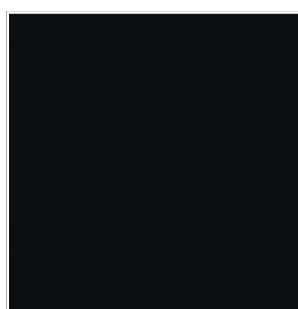

BLACK

INNE KOLORY



OTHER COLORS

BIAŁY TRANSPARENTNY



TRANSPARENT WHITE

SZARY DRZEWNY



WOODEN GREY

SZARY



GREY

CZARNY TRANSPARENTNY



TRANSPARENT BLACK

CZARNY LAZUR

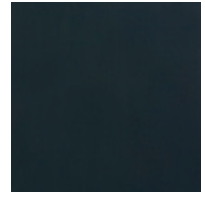

BLACK AZURE

SŁOMKOWY



STRAW

DĄB NATURALNY



NATURAL OAK

EGZOTYCZNY

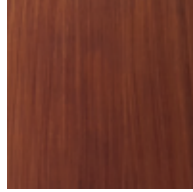

EXOTIC WOOD

KASZTAN

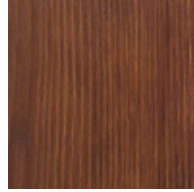

CHESTNUT

ZIELONY LAZUR



GREEN AZURE

COLORS IN USE

■ KOLORY W ZASTOSOWANIU

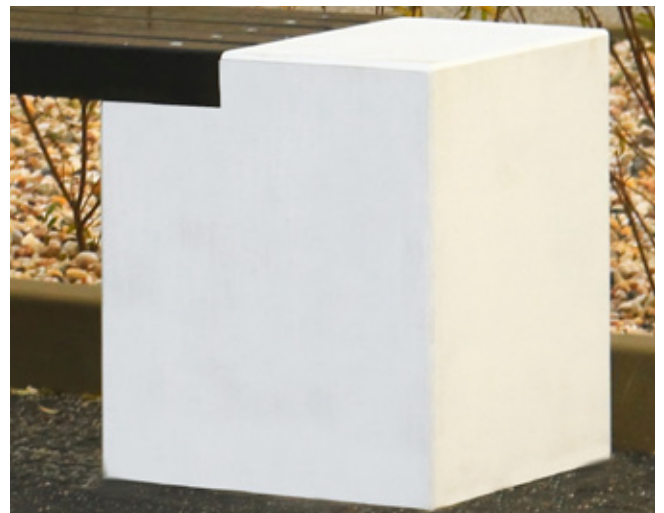
BETON NATURALNY SZARY
GREY NATURAL CONCRETEBETON BARWIONY
INTEGRALLY COLORED CONCRETEBETON MAŁOWANY
PAINTED CONCRETEBETON NATURALNY BIAŁY
WHITE NATURAL CONCRETE

SPIIS TREŚCI

1. Donice i kwietniki	7
2. Ławki i stoły	11
3. Kosze uliczne	17
4. Inny asortyment	20
5. Galeria wybranych realizacji	27

INDEX

1. <i>Planters</i>	7
2. <i>Benches and tables</i>	11
3. <i>Waste bins</i>	17
4. <i>Other products</i>	20
5. <i>Gallery of selected projects</i>	27

DONICE I KWIETNIKI

Udomowiamy naturę,
przybliżamy ją człowiekowi

PLANTERS

*We domesticate nature
and bring it closer to a man*





DONICE OKRĄGLE
CIRCULAR PLANTERS

deco

○ **MARYLA 2**

■ szary □ biały ■ barwiony ■ malowany

średnica	wysokość	waga	szt./paleta	waga palety
115 cm	80 cm	620 kg	1	620 kg

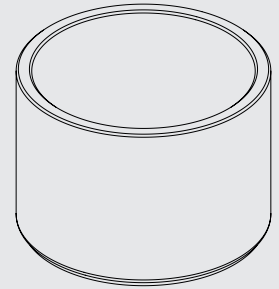
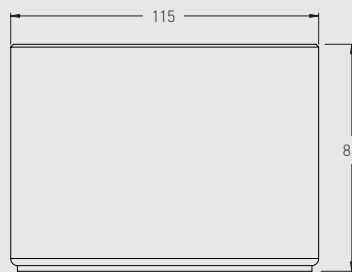

DONICE KWADRATOWE
SQUARE PLANTERS

deco

□ **ROCA**

■ szary □ biały ■ barwiony ■ malowany

długość	szerokość	wysokość	waga	szt./paleta	waga palety
100 cm	100 cm	100 cm	800 kg	1	800 kg

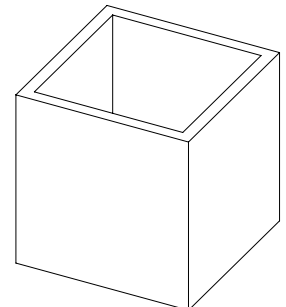
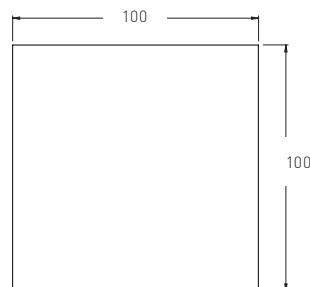

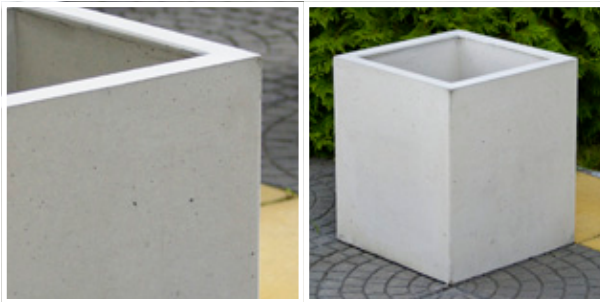

DONICE KWADRATOWE SQUARE PLANTERS

deco

□ ROSEL

■ szary □ biały ■ barwiony ■ malowany

długość	szerokość	wysokość	waga	szt./paleta	waga palety
40 cm	40 cm	45 cm	75 kg	6	450 kg

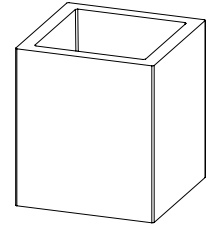
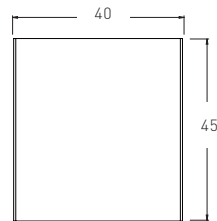

DONICE KWADRATOWE SQUARE PLANTERS

deco

□ ADA

■ szary □ biały ■ barwiony ■ malowany

długość	szerokość	wysokość	waga	szt./paleta	waga palety
60 cm	60 cm	60 cm	260 kg	4	1040 kg

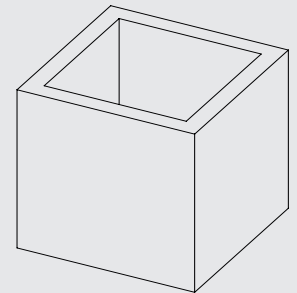
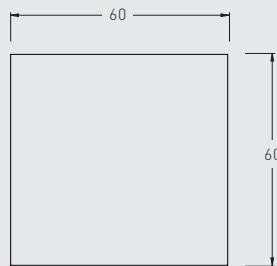

DONICE PROSTOKĄTNE RECTANGULAR PLANTERS

deco

□ REGINA

■ szary □ biały ■ barwiony ■ malowany

długość	szerokość	wysokość	waga	szt./paleta	waga palety
170 cm	50 cm	50 cm	420 kg	2	840 kg

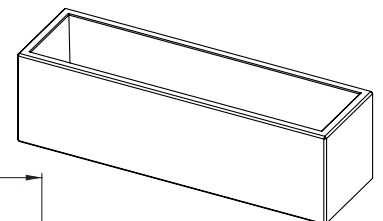
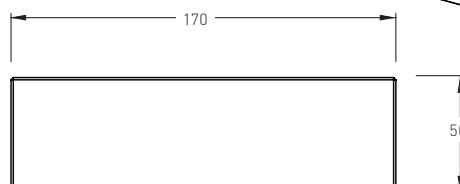



DONICE PROSTOKĄTNE RECTANGULAR PLANTERS

deco

 IRMINA
 barwiony impregnowany

długość	szerokość	wysokość	waga	szt./paleta	waga palety
70 cm	35 cm	25 cm	84 kg	9	756 kg

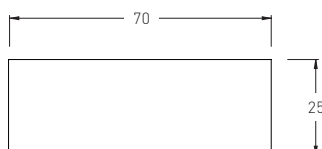
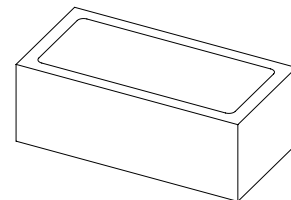

DONICE PROSTOKĄTNE RECTANGULAR PLANTERS

deco

 IRMA
 barwiony impregnowany

długość	szerokość	wysokość	waga	szt./paleta	waga palety
120 cm	40 cm	25 cm	191 kg	6	1146 kg

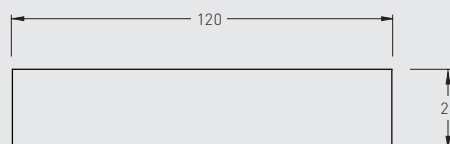
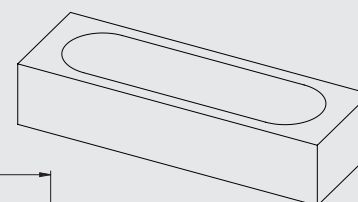

DONICE PROSTOKĄTNE RECTANGULAR PLANTERS

deco

 IRYDA
 barwiony impregnowany

długość	szerokość	wysokość	waga	szt./paleta	waga palety
125 cm	50 cm	40 cm	275 kg	2	550 kg

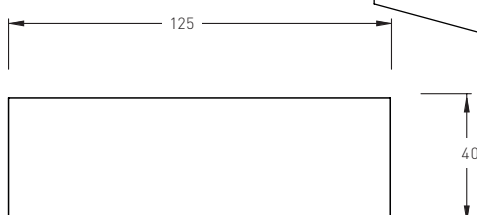
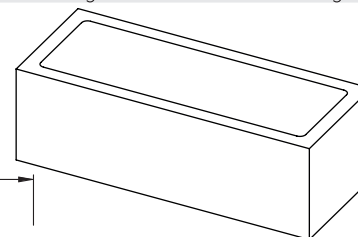

ŁAWKI I STOŁY

Dajemy chwilę na odpoczynek
i zauważenie drugiego człowieka

BENCHES & TABLES

*We give a moment to relax
and notice another person*





ŁAWKI BEZ OPARCIA
BENCHES WITHOUT BACKREST

deco

WEGA

■ szary ■ biały ■ barwiony ■ malowany

długość	szerokość	wysokość	waga	szt./paleta	waga palety
190 cm	40 cm	46,5 cm	300 kg	3	900 kg

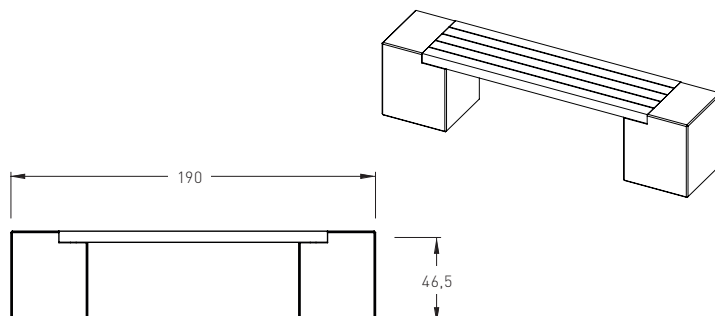

ŁAWKI BEZ OPARCIA
BENCHES WITHOUT BACKREST

deco

WISA

■ szary ■ biały ■ barwiony ■ malowany

długość	szerokość	wysokość	waga	szt./paleta	waga palety
187 cm	45 cm	45 cm	140 kg	6	840 kg

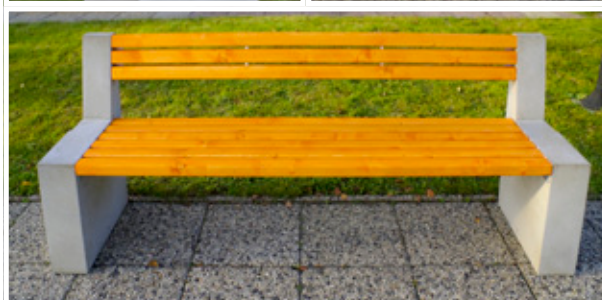
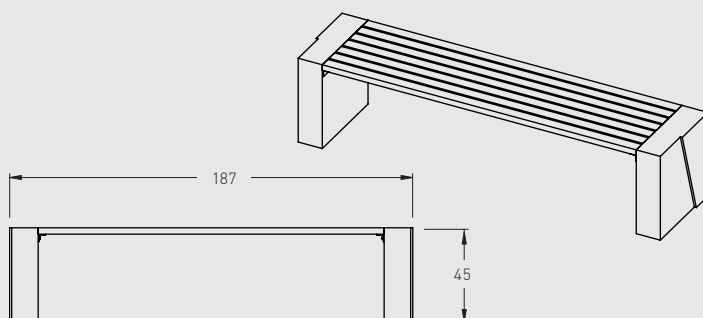

ŁAWKI Z OPARCIEM
BENCHES WITH BACKREST

deco

WISA

■ szary ■ biały ■ barwiony ■ malowany

długość	szerokość	wysokość	waga	szt./paleta	waga palety
187 cm	45 cm	80 cm	167 kg	6	1002 kg

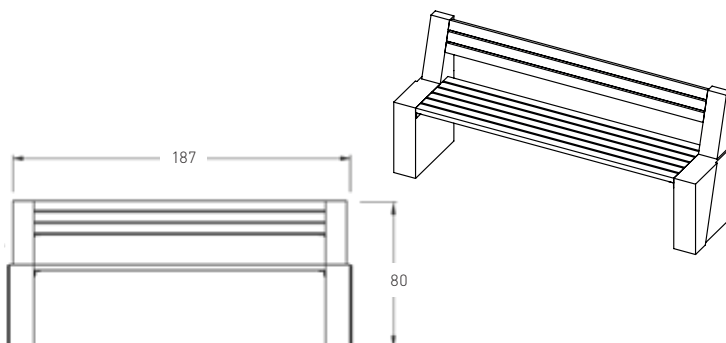



ŁAWKI BEZ OPARCIA
BENCHES WITHOUT BACKREST

deco

TARA

■ szary ■ biały ■ barwiony ■ malowany

długość	szerokość	wysokość	waga	szt./paleta	waga palety
100 cm	40 cm	46,5 cm	210 kg	2	420 kg
200 cm	40 cm	46,5 cm	340 kg	2	680 kg

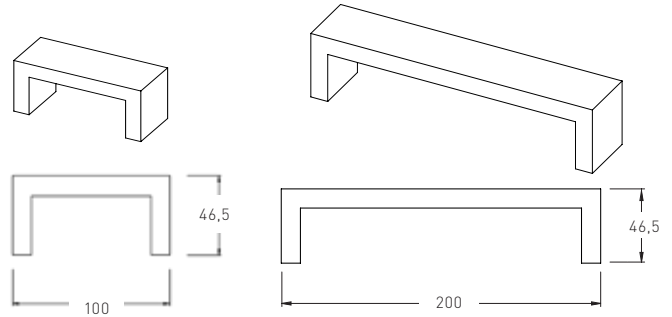

ŁAWKI i STOLY / BENCHES & TABLES





SIEDZISKA SEATS

deco

CUBE 41

■ szary □ biały ■ barwiony ■ malowany

długość	szerokość	wysokość	waga	szt./paleta	waga palety
41 cm	41 cm	45 cm	165 kg	6	990 kg

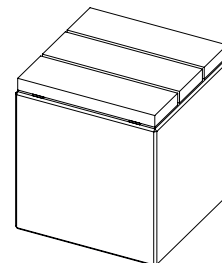
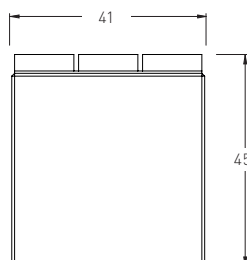

STOŁY BEZ FUNDAMENTU TABLES WITHOUT FOUNDATION

deco

WISA

■ szary □ biały ■ barwiony ■ malowany

długość	szerokość	wysokość	waga	szt./paleta	waga palety
140 cm	60 cm	75 cm	200 kg	5	1000 kg

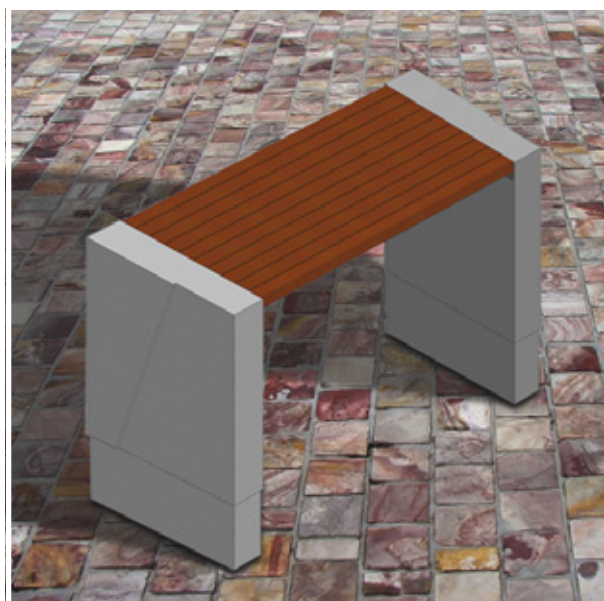
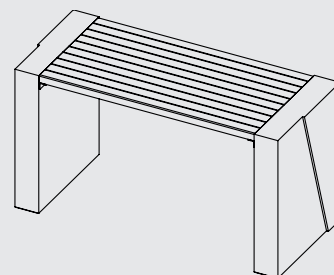
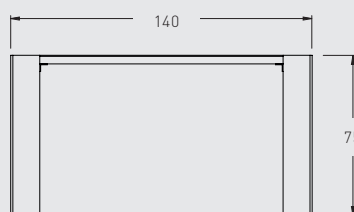

STOŁY Z FUNDAMENTEM TABLES WITH FOUNDATION

deco

WISA

■ szary □ biały ■ barwiony ■ malowany

długość	szerokość	wysokość	waga	szt./paleta	waga palety
140 cm	60 cm	75 cm	300 kg	3	900 kg

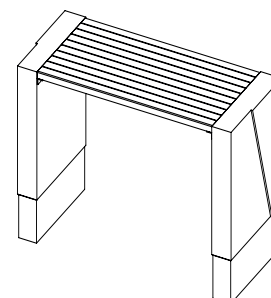
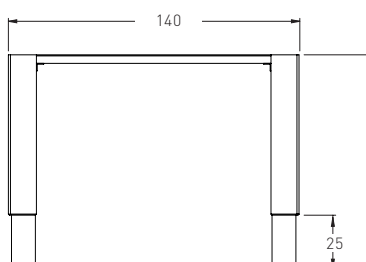



SIEDZISKA
SEATS

deco

LARGO

■ szary □ biały ■ barwiony ■ malowany

długość	szerokość	wysokość	waga	szt./paleta	waga palety
55 cm	80 cm	70 cm	290 kg	2	580 kg

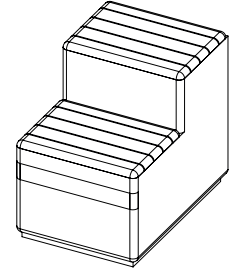
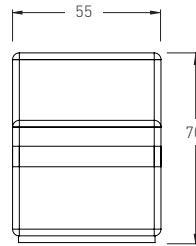

SIEDZISKA
SEATS

deco

LARGO P

■ szary □ biały ■ barwiony ■ malowany

długość	szerokość	wysokość	waga	szt./paleta	waga palety
110 cm	80 cm	70 cm	317 kg	2	634 kg

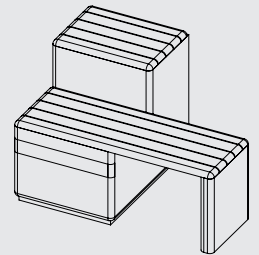
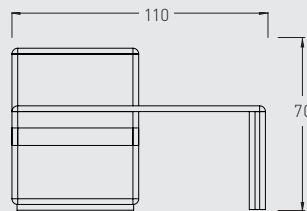

SIEDZISKA
SEATS

deco

LARGO DUO

■ szary □ biały ■ barwiony ■ malowany

długość	szerokość	wysokość	waga	szt./paleta	waga palety
165 cm	80 cm	70 cm	600 kg	1	600 kg

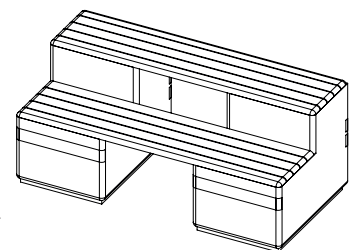
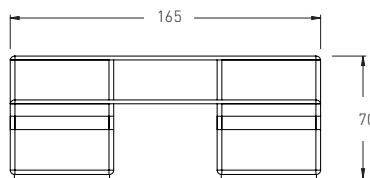



SIEDZISKA
SEATS

deco

RELAX

■ szary □ biały ■ barwiony ■ malowany

długość	szerokość	wysokość	waga	szt./paleta	waga palety
150 cm	50 cm	45 cm	750 kg	1	770 kg
200 cm	50 cm	45 cm	1100 kg	1	1130 kg

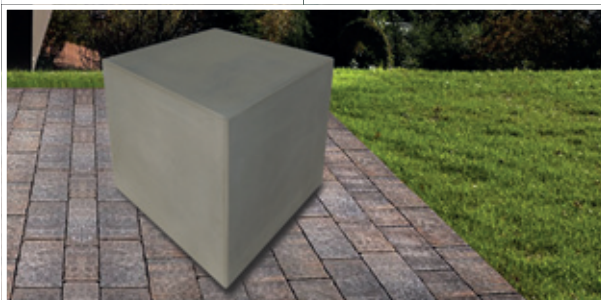
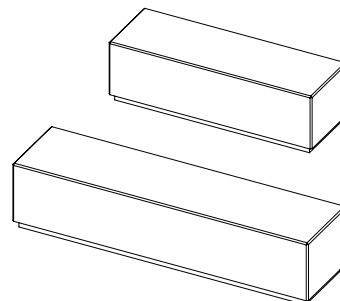
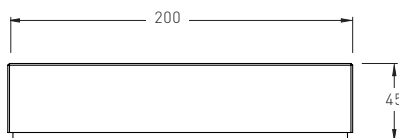
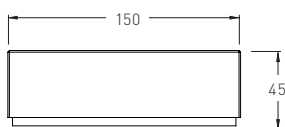

SIEDZISKA
SEATS

deco

CUBE 41

■ szary □ biały ■ barwiony ■ malowany

długość	szerokość	wysokość	waga	szt./paleta	waga palety
41cm	41cm	41 cm	160 kg	6	960 kg

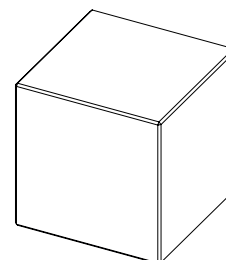
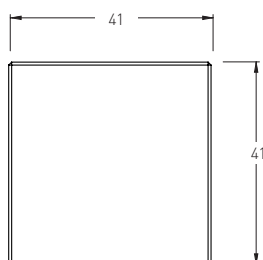

KOSZE ULICZNE

Porządkujemy ulice
umożliwiając każdemu dbanie o czystość

WASTE BINS

*We put streets in order
and give everyone a chance to keep them clean*





KOSZE KWADRATOWE SQUARE BINS

deco

☐ WEGA 30 Itr

■ szary □ biały ■ barwiony ■ malowany

długość	szerokość	wysokość	waga	szt./paleta	waga palety
40 cm	40 cm	46,5 cm	92 kg	6	552 kg

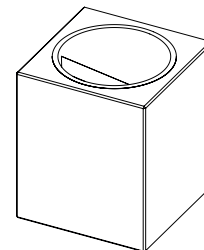
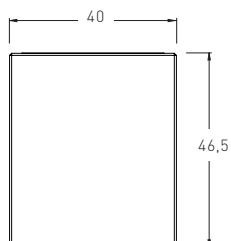

KOSZE PROSTOKĄTNE RECTANGULAR BINS

deco

☐ WISA 50 Itr

■ szary □ biały ■ barwiony ■ malowany

długość	szerokość	wysokość	waga	szt./paleta	waga palety
35 cm	45 cm	75 cm	139 kg	4	556 kg

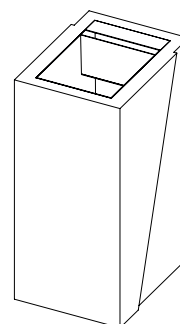
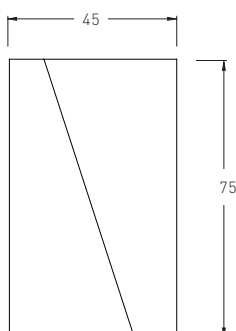



KOSZE ULICZNE / WASTE BINS





INNE PRODUKTY

Wciąż poszerzamy naszą ofertę,
bo wiemy, że miast i terenów zielonych
nie sposób zdefiniować w jednym katalogu

OTHER PRODUCTS

*We know that cities and green areas
are not definable in one catalogue
thus we keep on broadening our offer*



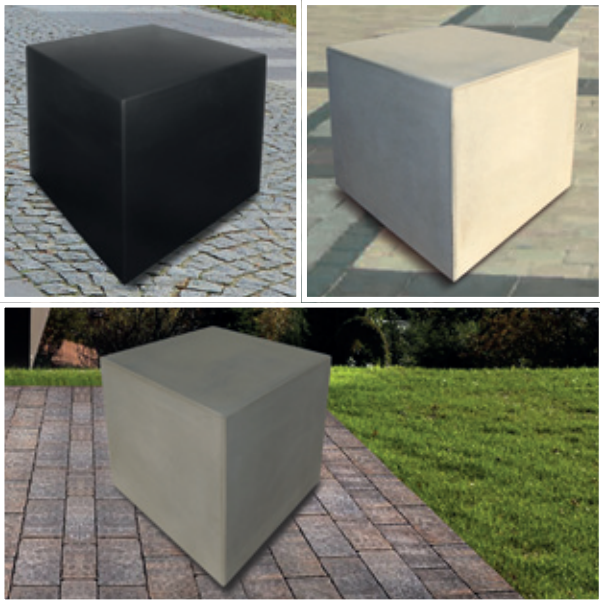

SŁUPKI PARKINGOWE
BOLLARDS

deco

ZAPORA 41 cm

■ szary □ biały ■ barwiony ■ malowany

długość	szerokość	wysokość	waga	szt./paleta	waga palety
41cm	41cm	41 cm	160 kg	6	960 kg

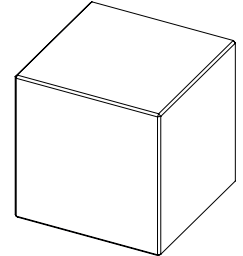
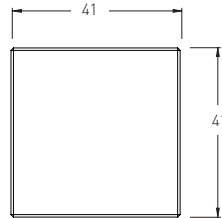

STOJAKI ROWEROWE
BICYCLE RACKS

BORG 3-6 stanowisk

■ szary □ biały ■ barwiony

długość	szerokość	wysokość	waga	szt./paleta	waga palety
202,5 cm	35 cm	131 cm	2100 kg	1	2120

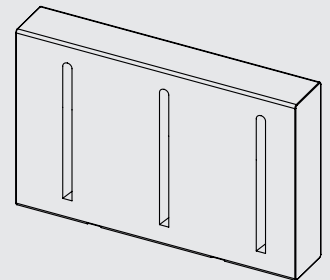
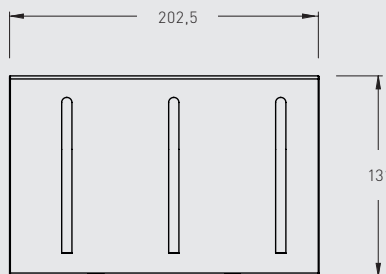



A

LAMPY ZEWNĘTRZNE
OUTDOOR LAMPS

MINI – LED 19 W/230 V **PLAN GLASS**

	nazwa wyrobu	wymiary [cm]	waga [kg]
A	PLAN GLASS MINI	32 x 15 x 43	15

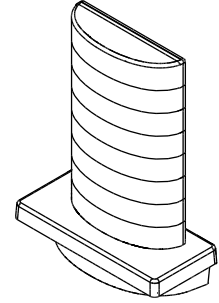
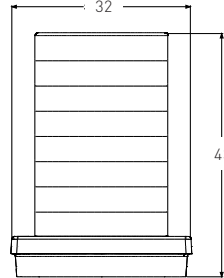

B

LAMPY ZEWNĘTRZNE
OUTDOOR LAMPS

MAXI – LED 19 W/230 V **PLAN GLASS**

	nazwa wyrobu	wymiary [cm]	waga [kg]
B	PLAN GLASS MAXI	32 x 15 x 68	19

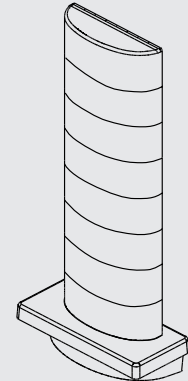
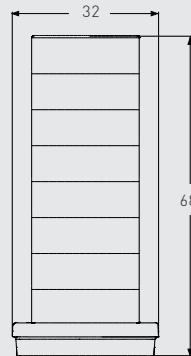

C

LAMPY ZEWNĘTRZNE
OUTDOOR LAMPS

SKOS – LED 19 W/230 V **PLAN GLASS**

	nazwa wyrobu	wymiary [cm]	waga [kg]
C	PLAN GLASS SKOS	24 x 32 x 26	12

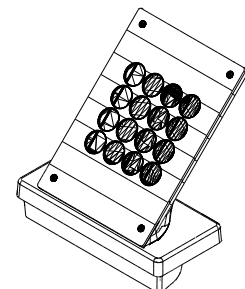
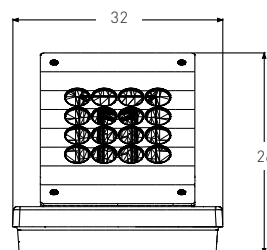

PROJEKTY INDYWIDUALNE

INDIVIDUAL PROJECTS

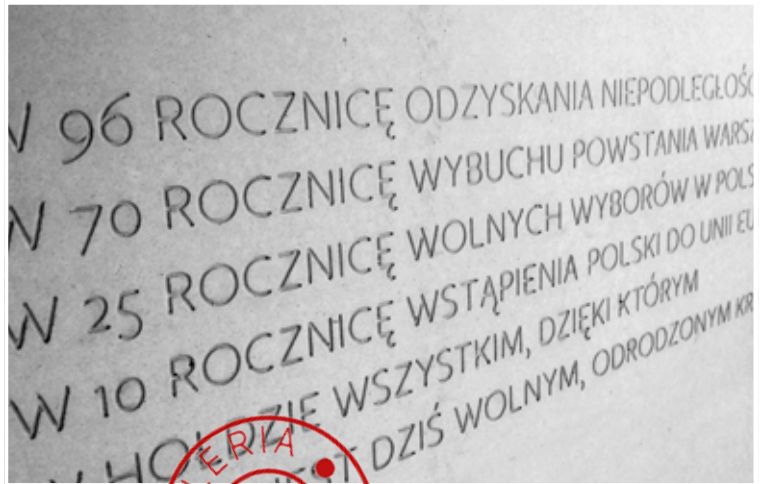

INNY ASORTYMENT / OTHER PRODUCTS



PROJEKTY INDYWIDUALNE

INDIVIDUAL PROJECTS

INNY ASORTYMENT / OTHER PRODUCTS

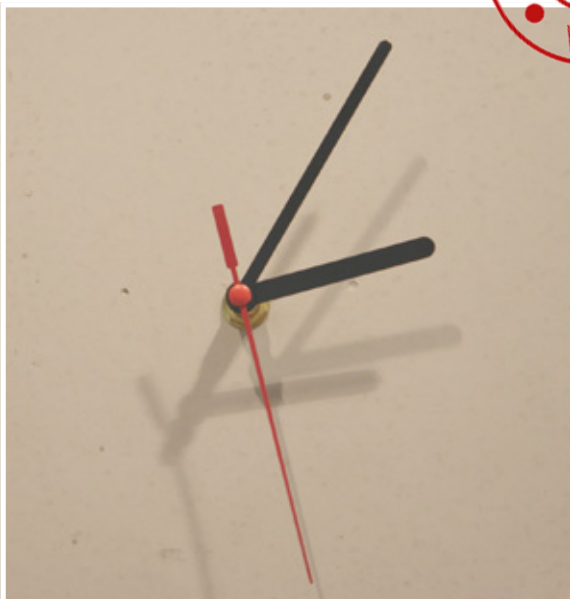

GALERIA WYBRANYCH REALIZACJI

GALLERY OF SELECTED PROJECTS





Londyn



Aquapark, Koszalin



Aquapark, Koszalin



MTP, Poznań



Browar Lubicz, Kraków



Park, Piła



Poznański Park Technologiczno-Przemysłowy



Wysogotowo, INEA-PARK



Skwer Czytelnika, Nowe Skalmierzyce



Centrum Kultury, Drawsko Pomorskie



Browar Lubicz, Kraków



Poznański Park Technologiczno-Przemysłowy



Park, Pita



Dworzec, Malmo



Wysogotowo, INEA-PARK



Wyroby klasy PREMIUM

STYL-BET DLA POLSKICH PROJEKTANTÓW

Biblioteka CAD

Rysunki CAD

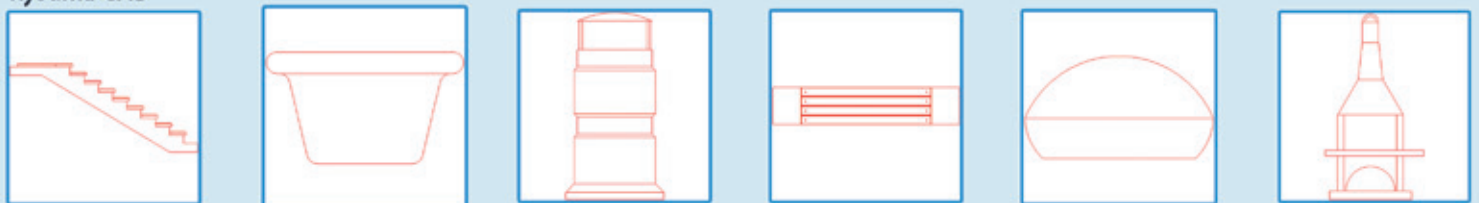

Modele 3D



Zdjęcia



KONTAKT

Baza biblioteki CAD



www.archispace.pl



Producent



www.styl-bet.pl





STYL-BET

Przedsiębiorstwo Wielobranżowe Jurewicz i Paradowski sp. jawna

ul. Reintera 6

78-500 Drawsko Pomorskie

tel. 94 363 30 76

fax. 94 363 33 78

biuro@styl-bet.com.pl

www.styl-bet.pl

